

An ISO 9001:2015 Certified Company

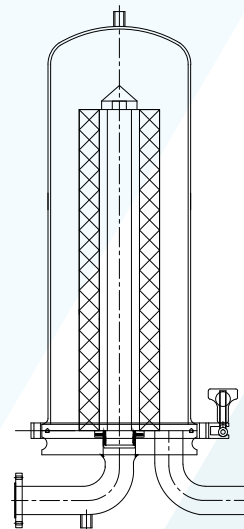

[www.arisfiltration.com](http://www.arisfiltration.com)

# CARTRIDGE FILTER HOUSINGS

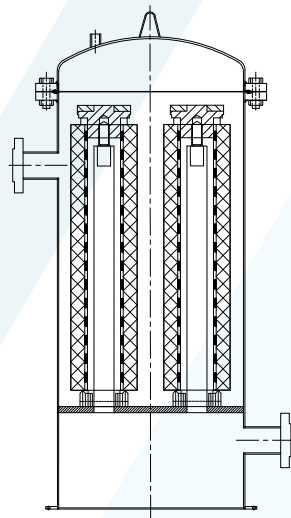

## Technical Specifications

### Sizes ( Cartridge Filter Housing Suitable For)

1 No. To 500 Nos. Of Cartridges in Single Housing  
 2", 2.5", 4", 6" & 8" Diameter Of Cartridge  
 10", 20", 30" & 40" Length Of Cartridge

### Flow Rate

Capacity : Up to 2000 m<sup>3</sup>/hr & more

### Material Of Construction

SS 316L SS 316 SS 304 Mild Steel  
 POLYPROPYLENE On Any Metal  
 RUBBER LINING On Any Metal  
 TEFLON LINING On Any Metal  
 TEFLON COATING On Any Metal

### Type Of Fitting (Cartridge)

Double Open End (DOE) Type  
 Code 7 ( 226 O Ring) Design  
 Code 3 ( 226 O Ring) Design  
 NPT Threaded Connection Type

### End Connection

NPT / BSP Threaded  
 Flanged Table E / Table F  
 ANSI B 16.5 Flanged  
 Din Standard  
 Tri Clover Adaptors

### Gasket / O Ring Material

Neoprene  
 Nitrile  
 Silicone  
 Viton  
 EPDM  
 PTFE  
 Sprial Wound  
 BUNA-N

# BAG FILTER HOUSINGS

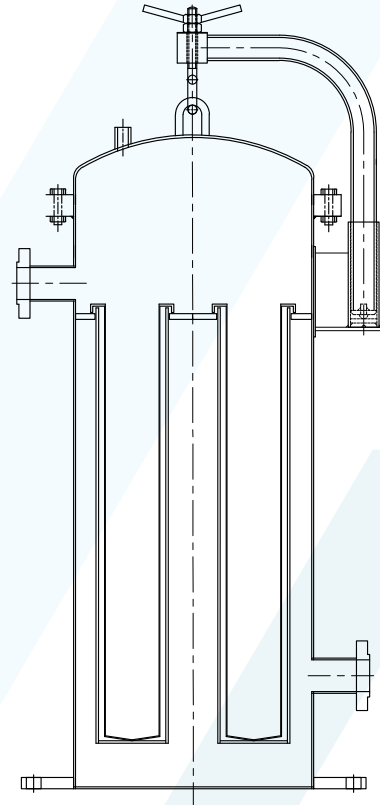

## Technical Specifications

Sizes ( Bag Filter Housing Suitable For)		
Diameter in inch.	Length in inch.	No. of Bags Per Housing.
4" Dia.	10" Long	1 No.
4" Dia.	20" Long	1 No.
7" Dia.	16" Long	1 No.
7" Dia.	32" Long	1 No.
7" Dia.	32" Long	2 No.
7" Dia.	32" Long	3 No.
7" Dia.	32" Long	4 No.
7" Dia.	32" Long	5 No.
7" Dia.	32" Long	6 No.
7" Dia.	32" Long	7 No.
7" Dia.	32" Long	9 No.

Flow Rate
Capacity : Up to 2000 m3/hr & more

Material Of Construction
SS 316L SS 316 SS 304
MS
POLYPROPYLENE
RUBBER LINING On Any Metal

Type Of Fitting (Bag)
PP Collar Bag
Snap Band Bag
SS Ring Bag
Flange Collar Bag

End Connection
NPT / BSP Threaded
Flanged Table E / Table F
ANSI B 16.5 Flanged
Din Standard
Tri Clover Adaptors

Gasket / O Ring Material
Neoprene
Nitrile
Silicone
Viton
EPDM
PTFE

# BASKET FILTER & STRAINERS

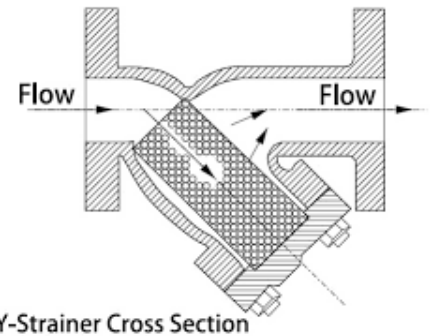
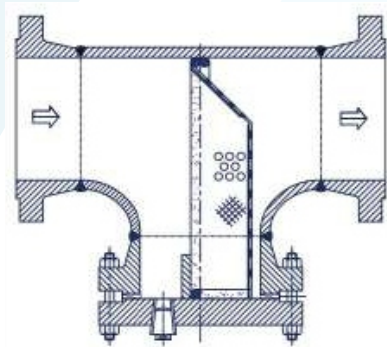
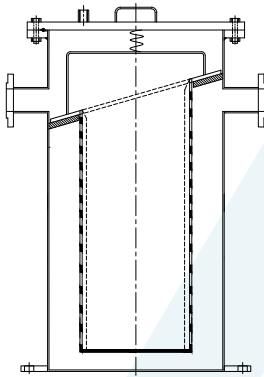
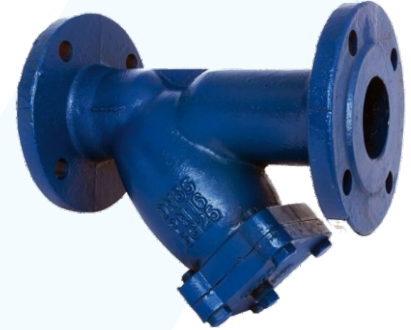

## Technical Specifications

### Sizes

1" Line Size To 24" Line Size & More

### Flow Rate

Capacity : Up to 2000 m<sup>3</sup>/hr & more

### Material Of Construction

SS 316L SS 316 SS 304

Mild Steel

POLYPROPYLENE On Any Metal

RUBBER LINING On Any Metal

### Basket Element Design Available

Single Basket Design

Multi Basket Design

Pleated Basket Design

Wrap Round Basket Design

### End Connection

NPT / BSP Threaded

Flanged Table E / Table F

ANSI B 16.5 Flanged

Din Standard

Tri Clover Adaptors



# DUPLEX FILTER HOUSINGS

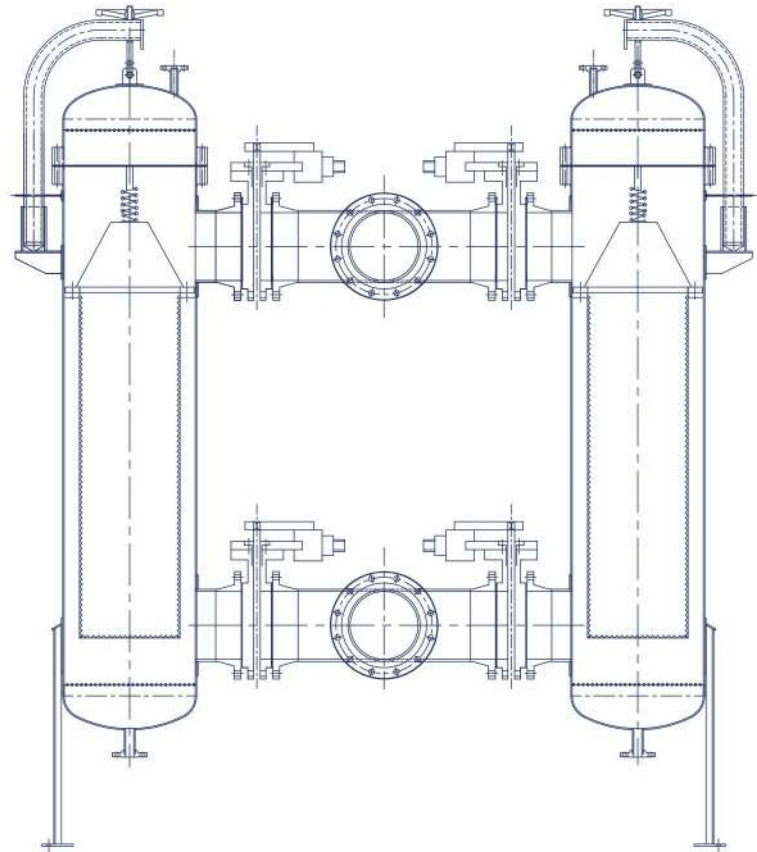

## Technical Specifications

### Sizes

1/4" Line Size To 24" Line Size & More

### Flow Rate

Capacity : Up to 2000 m<sup>3</sup>/hr & more

### Material Of Construction

SS 316L SS 316 SS 304

Mild Steel

POLYPROPYLENE On Any Metal

RUBBER LINING On Any Metal

### Design

Customized

### Type Of Valve Available

3 - Way Ball Valve

Butterfly Valve With Tee

### End Connection

NPT / BSP Threaded

Flanged Table E / Table F

ANSI B 16.5 Flanged

Tri Clover Adaptors

# CARTRIDGE FILTERS



## PP Spun Bonded Filter Cartridge

Description	
Diameter	2.5", 4", 4.5"
Internal Diameter	28mm
Length	10", 20", 30", 40"
Material of Construction	100% Polypropylene
Micron Rating	1, 5, 10, 25, 50, 75, 100
Configuration	DOE, SOE



## PP Wound Filter Cartridge

Description	
Diameter	2.5", 4", 4.5"
Internal Diameter	28mm
Length	10", 20", 30", 40"
Core	PP, Stainless Steel
Material of Construction	100% Polypropylene
Micron Rating	1, 5, 10, 25, 50, 75, 100
Configuration	DOE, SOE



## Glass Fiber Wound Filter Cartridge

Description	
Diameter	2.5", 4", 4.5"
Internal Diameter	28mm
Length	10", 20", 30", 40"
Core	Stainless Steel
Material of Construction	Glass Fiber
Micron Rating	1, 5, 10, 25, 50, 75, 100
Configuration	DOE, SOE



## PP Pleated Filter Cartridge

Description	
Diameter	68mm
Internal Diameter	28mm
Length	10", 20", 30", 40"
Material of Construction	Polypropylene & PTFE
Micron Rating	0.2, 0.45, 1, 2, 5, 10
Configuration	DOE, SOE & Code 7



## Resin Bonded Filter Cartridge

Description	
Diameter	64mm
Internal Diameter	28mm
Length	10", 20", 30", 40"
Material of Construction	Phenolic & Cellulose Resin B.
Micron Rating	1, 5, 10 & 20
Construction	Grooved & Ungrooved
Configuration	DOE

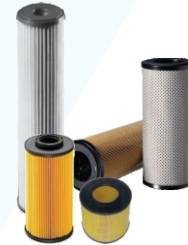

## Paper Pleated Filter Cartridge

Description	
Diameter	2.5", 4", 4.5" & Customized
Internal Diameter	28mm & Customized
Length	10", 20", 30", 40" & Customized
MOC	SS/GI/PP/PU/PLASTIC
MOC of Media	Paper, PP, Polyester, HDPE, Nylon
Filter Design	Wrap Round & Pleated
Micron Rating	1, 2, 5, 10, 25, 50, 75, 100, 300, 500
Construction	Adhesive Joint
Configuration	DOE, SOE & Customized



## Stainless Steel Filter Cartridge

Description	
Diameter	2.5", 4", 4.5" & Customized
Internal Diameter	28mm & Customized
Length	10", 20", 30", 40" & Customized
MOC	SS 304, SS 316 & SS 316L
MOC of Media	316L Non-Woven Fiber Felt
Filter Design	Wrap Round & Pleated
Micron Rating	1, 2, 3, 5, 10, 50, 75, 100
Construction	100% Welded & Adhesive
Configuration	DOE, SOE, Code 7, NPT & BSP



## SS Sintered Powder Filter Cartridge

Description	
Diameter	2", 2.5" & 3"
Internal Diameter	28mm, 40mm & 50mm
Length	10", 20", 30", 40" & Customized
MOC	SS 316 & SS 316L
Filter Design	Cylinder
Micron Rating	0.2, 1, 2, 3, 5, 10, 50, 75, 100
Construction	100% Welded
Configuration	DOE, SOE, Code 7, NPT & BSP

# Dust Collection



## Dust Collection Filter Cartridge/Elements

Sizes	
Standard & Customized	
Description	
MOC of Caps	SS/GI/Al/PU-RUBBER
MOC of Media	Cellulose Paper, PP, Spun Bonded Polyester, HDPE, Nylon
Micro Rating	1, 5, 10, 25, 50
Coating	PTFE, Antistatic(Aluminum Coating), Oil & Water Repellant
Configuration	Lugs Type, Collar Type, Flange type & Tie-Rod Type Fitting

# PANEL FILTER



## Technical Specifications

Sizes
Standard & Customized
MOC of Frame
SS 316 SS 304
Aluminum
Gi
Micron Rating
0.2, 0.3, 1, 2, 5, 10, 25, 50, 100 & More

MOC of Media
PP, Polyester, Synthetic Non-Woven
HDPE Mesh
SS Mesh
Nylon Mesh
Glass Fiber
Type of Filter
HEPA Filter
Pre Filter
V Cell Filter
Pocket Filter

# FILTER BAGS



## Liquid Filter Bags



### Technical Specifications

#### Standard Sizes (Customized sizes are available)

- 4" X 10" Long
- 4" X 17" Long
- 4" X 20" Long
- 7" X 17" Long
- 7" X 32" Long

#### Configuration

- Fused (Welded)
- Stitched Types

#### Filtration Rating

1, 5, 10, 20, 50, 100 & 200 Micron

#### Fitment Configuration

- PP Collar
- SS Ring
- Snap Band Fit

#### Filter Media

- Polypropylene
- Polyester
- Nylon
- HDPE

## Dust Collection Filter Bags



### Technical Specifications

#### Standard Sizes (Customized sizes are available)

Customized Sizes are available

#### Micro Rating

1, 5, 10, 25, 50, 100, 250, 500

#### Configurations

- Snap band type
- Flange collar type
- customized

#### Available Coating & Treatment

- Antistatic Treatment with copper wire
- Antistatic treatment with stainless steel fiber
- Water & Oil Repellent
- PTFE Coating & Laminated

#### Filter Media

- Woven Media
- Non-Woven Media
- Glass Fiber



## Coolant Filter Paper Roll



### Technical Specifications

Sizes (Customized sizes are available)
400 mm to 3000 mm width Customized sizes are available
Configuration
30 GSM to 200 GSM
Filtration Rating
1, 5, 10, 20, 50, 100 Micron

Filter Media
Polypropylene
Polyester
Viscose
Needle Punch

## Filter Media

### HIGH LOFT GLASS FIBER

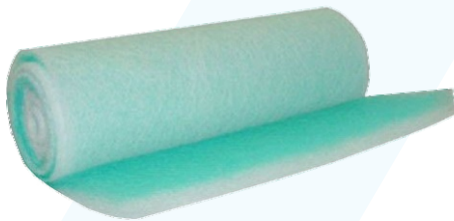

### Technical Specifications

Sizes
Customized Sizes are available
Micro Rating
1, 5, 10, 25, 50, 100

### HIGH LOFT POLYESTER



Filter Media	
Woven Media	Polypropylene
Non-Woven Media	Polyester
Glass Fiber	Nylon
Cotton	HDPE

## Sintered Filter Tubes



### Technical Specifications

<b>Sizes (Customized sizes are available)</b>	
10", 20", 30", 40" & Customized	
<b>Diameter</b>	
25MM, 38MM, 44MM, 50MM, 65MM, 75MM	
<b>Filteration Rating</b>	<b>Filter Media</b>
0.2, 0.45, 1, 5, 10, 20, 50 Micron	SS 316L, SS 304L

## Sintered Disc Filter

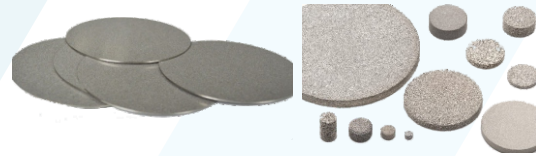

### Technical Specifications

<b>Sizes</b>
Customized
<b>Filteration Rating</b>
0.2, 0.45, 1, 5, 10, 20, 50 Micron
<b>Filter Media</b>
SS 316L, SS 304L

## Multilayer Disc Filters

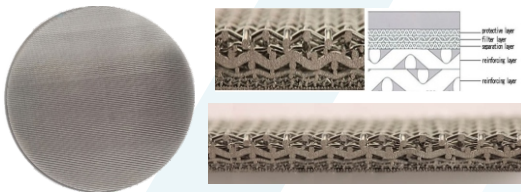

### Technical Specifications

<b>Sizes</b>	
Customized	
<b>Thickness</b>	<b>Layer</b>
1.7 mm	5
<b>Filteration Rating</b>	<b>Filter Media</b>
1, 5, 10, 20, 50 Micron	SS 316L, SS 304L

## Wiremesh Disc Filters

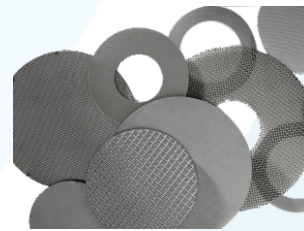

### Technical Specifications

<b>Sizes</b>
Customized
<b>Filteration Rating</b>
2, 5, 10, 20, 50, 100 Micron
<b>Filter Media</b>
SS 316L, SS 304L

## Spargers / Silencer



### Technical Specifications

<b>Sizes</b>	
Customized	
<b>Filteration Rating</b>	<b>Filter Media</b>
1, 5, 10, 20, 50 Micron	SS 316L, SS 304L Sintered Bronze

## Sintered Fiber Fabric

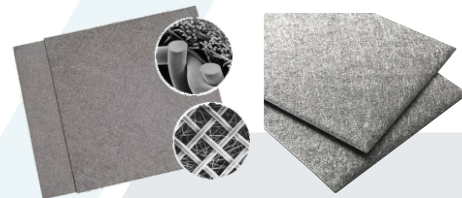

### Technical Specifications

<b>Sizes</b>	
Customized	
<b>Filteration Rating</b>	<b>Filter Media</b>
1, 5, 10 Micron	SS 316L, SS 304L

# OTHER FILTRATION PRODUCTS



## Wedge Wires



### Technical Specifications

<b>Sizes</b>
Customised
<b>Filteration Rating</b>
50, 75, 100, 150, 200, 500 Micron
<b>Types</b>
Cylinder, Screen
<b>Filter Media</b>
SS304, SS316, SS316L

## Compressed Air Filters



### Technical Specifications

<b>Sizes</b>
Customised
<b>Filteration Rating</b>
0.01, 0.1, 1, 5, 10 Micron
<b>Fitting</b>
Customised
<b>Filter Media</b>
Foam Media + Glass Fiber Media

## Replacement Filters



### Technical Specifications

<b>Sizes</b>	<b>Make</b>
As Per Part Number	Parker, Hydac, MP FILTRI, Donaldson, etc.

## INDUSTRIES WE SERVE

- Automobiles
- Breweries
- Cement
- Chemical
- Constructions
- Dairy
- Fertilizers
- Food & Beverages
- Foods Industries
- General Households
- Mines
- Oil
- Paints
- Paper/Board Mills
- Pharmaceuticals
- Rice/Dal/Flour Mills
- Soft Drink
- Sugar
- Thermal Power Plants
- Textile
- Other Allied Industries



An ISO 9001:2015 Certified Company

### ARIS FILTRATION

📍 H-203, Shantiniketan Solitaire,  
Opp. Vrundavan Party Plot,  
Beside Nikol Police Station,  
Nicol, Ahmedabad - 382350. Gujarat.



☎ +91 99791 85269  
☎ +91 73835 22858  
✉ info@arisfiltration.com  
✉ sales@arisfiltration.com  
🌐 www.arisfiltration.com